

FLEX8EX

User's Manual

Table of Contents

	Page
1. Introduction	3
2. Radio Controlled Safety	4
3. General System Information	
A. Transmitter Handset	
1. External Illustration (Standard Push Button Configuration)	5
2. Internal Illustration	6
B. Receiver Unit	
1. External Illustration	7
2. Internal Illustration	8
4. Function Settings	
A. Transmitter Handset	
1. System Channel Settings	9
2. Continuous Transmitting Time Adjustment	9
3. Push Button Functions with LED Displays	
a. Standard Push Button Configuration (Transmitter Toggle)	10
b. Standard Push Button Configuration (A/B Selector)	11
c. Inline Push Button Configuration (Transmitter Toggle)	12
d. Inline Push Button Configuration (A/B Selector)	13
4. Channel Change via Push Buttons	14
5. Program 4-digit Security Code	15
6. I-Chip	16
B. Receiver Unit	
1. System Channel Settings	17
2. Output Relay Configurations	
a. Output Relay Types	18
b. Output Relay Action at 2 nd Speed	18~19
c. ON/OFF Push Button Function	19
d. Magnet ON/OFF Push Button Function	20
e. Brake Function	20
f. External Warning Function	20
g. Momentary Contact	20
h. Toggled Contact	20

i.	3 rd Speed Push Button Function	20
j.	Auxiliary STOP Push Button Function	21
k.	Pitch & Catch Function	21
3.	Receiver Auto-Scanning Settings	21
4.	Dip-switch Settings	
a.	Interlocked Functions	22
b.	Non-interlocked Functions	23
5.	Jumpers Settings	24
6.	I-CHIP Programming Port	25
7.	Voltage Settings	25
5.	System Channels Table	26
6.	Receiver Installation	
A.	Output Relay Contact Diagram	27
B.	Pre-Installation Precautions	28
C.	Step-By-Step Installation	28~29
D.	System Testing	29
7.	Operating Procedure	
A.	Transmitter Operation	
1.	General Operating Procedure	30~31
2.	A/B Selector Push Button Operating Procedure	31
3.	3 rd Speed Push Button Operating Procedure	31
4.	Pitch & Catch Operating Procedure	32
5.	Automatic Channel Scanning Operating Procedure	32
6.	Changing Transmitter Batteries	32
B.	Status Light Indicators & Warnings	
1.	Transmitter Status Light Indication	33
2.	Receiver Status Light Indication	34
3.	Receiver SQ Light Indication	34
4.	Receiver POWER Light Indication	34
5.	Receiver COM Light Indication	34
C.	Trouble Shooting Tips	35
8.	System Specifications	36
9.	Spare Parts	37
10.	EU Declaration of Conformity	38

1. Introduction

The **FLEX** radio remote control systems are designed for control of industrial equipment and machinery such as overhead traveling cranes, jib cranes, gantry cranes, tower cranes, electric hoists, winches, monorails, conveyor belts, mining equipment and other material handling equipment where wireless control is preferred.

Each **FLEX** system consists of a transmitter handset and receiver unit. Other standard-equipped accessories include transmitter waist belt, spare transmitter power key, clear vinyl pouch, “AA” alkaline batteries, compass direction decal sheet and user’s manual.

List of notable features include:

- * 62 user-programmable channels – Advanced synthesized RF controls with 62 built-in channels, no more fixed channel and fragile quartz crystals to break.
- * Automatic channel scanning receiver – No more hassle of climbing up the crane to change receiver channels.
- * Over one million unique ID codes (20bit) – Each and every Flex system has its own unique ID codes and serial number, never repeats.
- * Advanced controls – The Flex system utilizes advanced microprocessor controls with 32bit CRC and Hamming Code, which provide ultra fast, safe, precise, and error-free encoding and decoding.
- * Unique I-CHIP design – The I-CHIP functions in a way that is very similar to SIM card used on mobile phones, with the ability to transfer system information and settings from one transmitter to another without the hassle of resetting the spares.
- * Reliable push buttons – The in-house designed push buttons with gold-plated contacts are rated for more than one million press cycles.
- * Low power consumption – Requires only two “AA” Alkaline batteries for more than 150 hours of operating time between replacements.
- * Ultra-durable nylon and fiberglass composite enclosures – Highly resistance to breakage and deformation even in the most abusive environments.
- * Full compliance – All systems are fully complied with the FCC Part-15 Rules, European Directives (Safety, EMC, R&TTE, Machinery) and Industry Canada Specifications (IC).

2. Radio Controlled Safety

Flex radio remote control system should be operated by persons with sufficient amount of knowledge and skill in crane operation and safety. Persons being trained to operate a radio remote controlled crane should possess the knowledge of all hazards peculiar to radio remote controlled crane operation, ability to judge distance and moving objects, equipment capacity and radio remote controlled safety rules. Radio remote controlled cranes should not be operated by any person with insufficient eyesight, hearing, illness, and under influence of drugs and medications that may cause loss of crane control.

Below are some general operating safety tips that should be strictly followed when operating a radio remote controlled crane.

1. Prior to crane operation always check the transmitter handset for any damage that might inhibit proper crane operation.
2. Always check if the red emergency stop button is working properly prior to crane operation.
3. Check the Status LED on the transmitter for any signs of low battery power (refer to page 33).
4. Check the Status LED on the transmitter for any signs of irregularities (refer to page 33).
5. The crane limit switches should be checked prior to crane operation or at the beginning of each shift. When checking limit switches the hoist should be centered over an area free of personnel and equipment.
6. If the power to the crane is removed, the operator should turn off the transmitter power immediately until the power to the crane is restored.
7. If the crane fails to respond properly to operator's command the operator should stop operation, turn the transmitter power off, and then report the condition to their supervisor.
8. The transmitter power should be turned off after each use. If the transmitter handset is not in use always turn the power off and stored it in a safe or designated location. Never leave the transmitter handset unattended in the working area.
9. Make sure the system is not set to the same channel as any other Flex systems in use within a distance of 300 meters (900 feet).
10. Never operate a crane or equipment with two transmitter handsets at the same time unless they are programmed with "Pitch & Catch" function. For information on the "Pitch & Catch" feature, please refer to page 21 and page 32 of this manual.

3. General System Information

A. TRANSMITTER HANDSET

1. External Illustration (Standard Push Button Configuration)

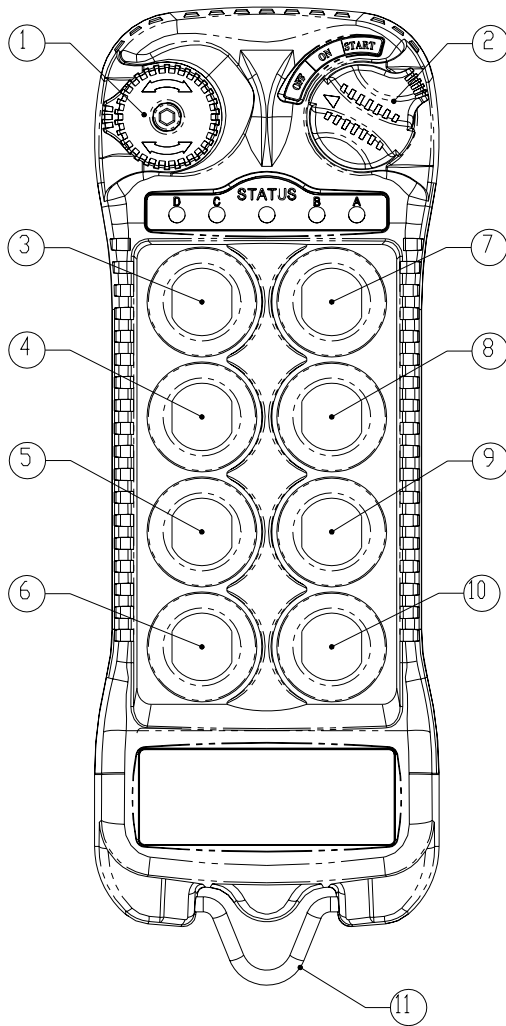

(Fig. 01)

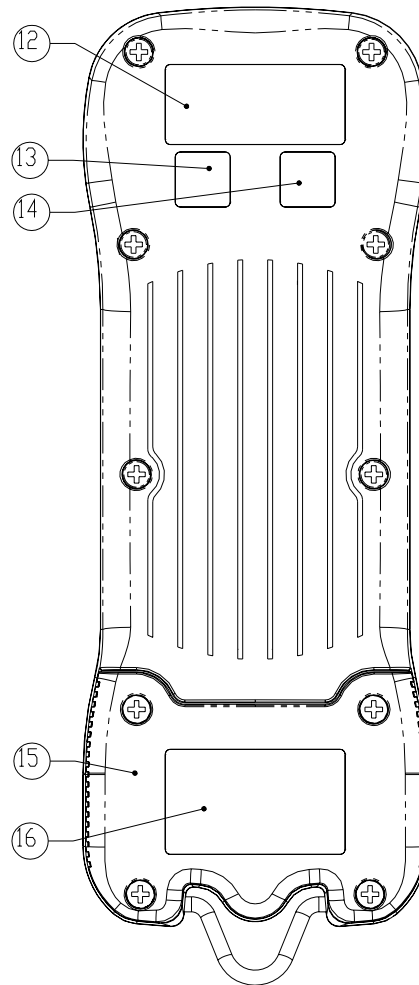

(Fig. 02)

- | | |
|-------------------------------|--------------------------|
| 1. Emergency Stop Button | 9. Push Button #5 |
| 2. Removable Power Key Switch | 10. Push Button #7 |
| 3. Push Button #2 | 11. Strap Ring |
| 4. Push Button #4 | 12. System Information |
| 5. Push Button #6 | 13. System Channel |
| 6. Push Button #8 | 14. Crane Number |
| 7. Push Button #1 | 15. Battery Cover |
| 8. Push Button #3 | 16. Approval Information |



B. RECEIVER UNIT

1. External Illustration

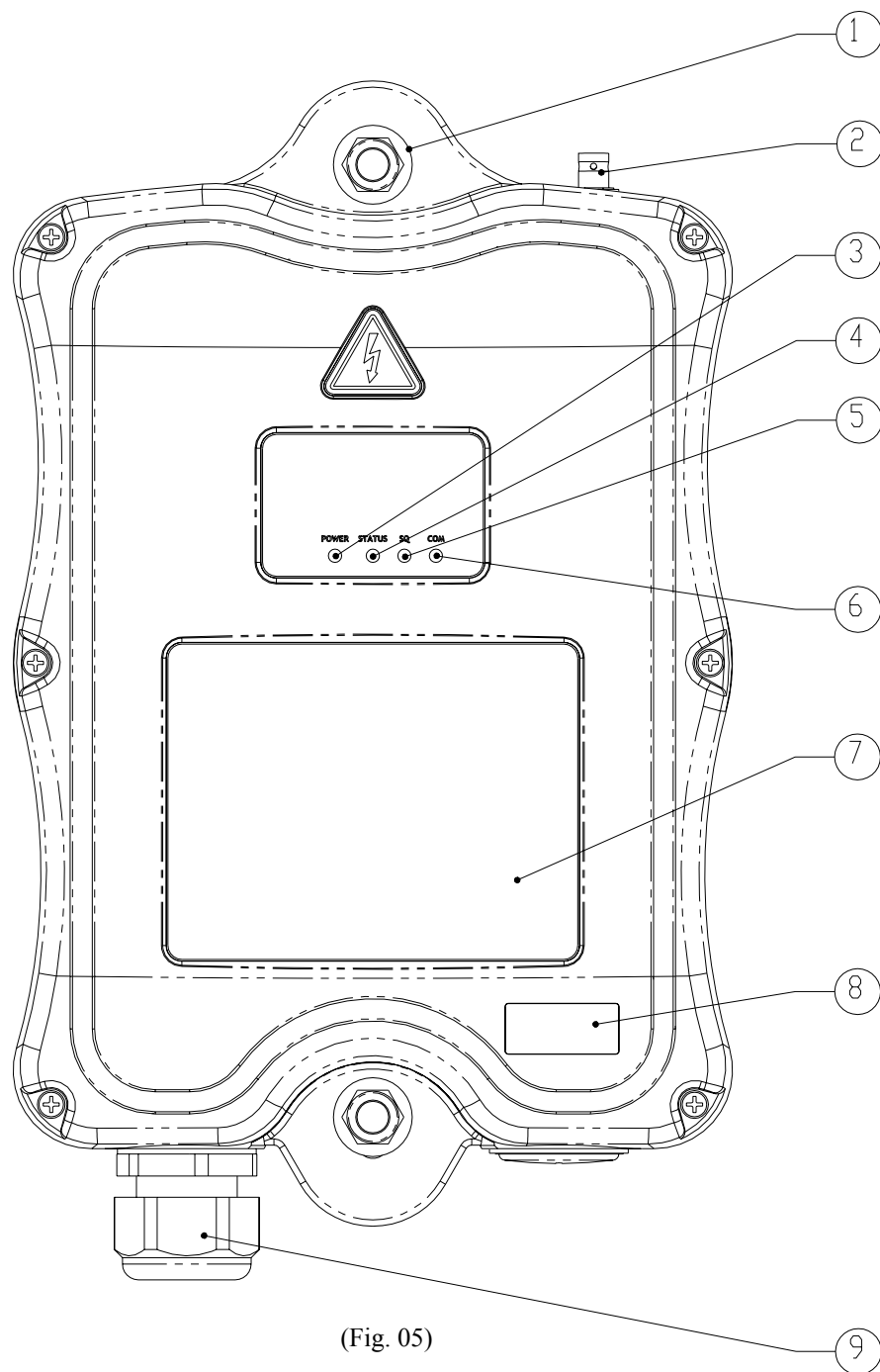

(Fig. 05)

- | | |
|--------------------------------|---------------------------|
| 1. Shock Mount | 6. COM LED Display |
| 2. External Antenna (BNC) Jack | 7. Output Contact Diagram |
| 3. Power LED Display | 8. System Information |
| 4. Status LED Display | 9. Cord Grip |
| 5. SQ LED Display | |

2. Internal Illustration

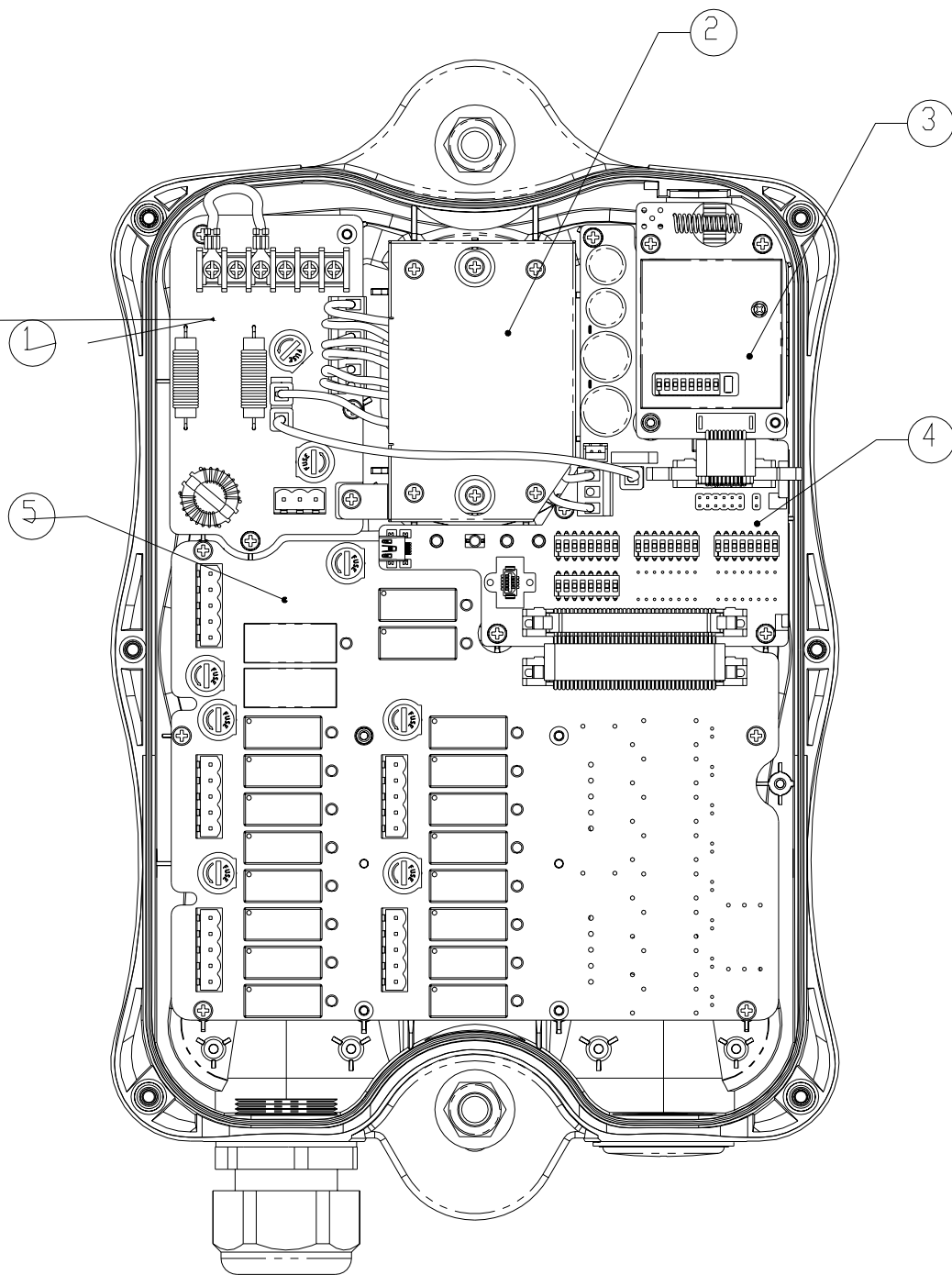

(Fig. 06)

- | | | | |
|----|-------------------|----|--------------------|
| 1. | AC Line Filter | 4. | Decoder Module |
| 2. | Power Transformer | 5. | Output Relay Board |
| 3. | Receiving Module | | |

4. Function Settings

A. TRANSMITTER HANDSET

1. System Channel Settings

(Fig. 07)

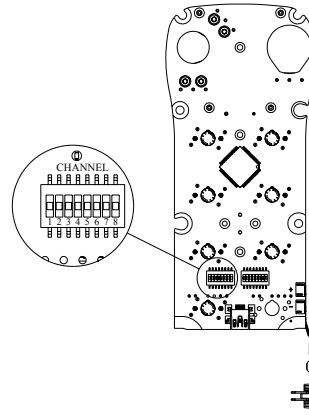

Set the transmitter channel by adjusting the channel dip-switch located on the backside of the transmitter encoder board (refer to Fig. 07 above). Only the first six (6) positions are used for channel programming (refer to Fig. 08 below). The system channels table located on page 26 illustrates which dip-switch setting corresponds to which channel. Once the transmitter channel is altered do make sure to change receiver channel as well. The channel on both transmitter and receiver must be identical in order for system to work. To change receiver channel please refer to page 17.

Example:

(Fig. 08)

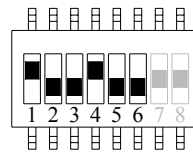

Top slot → “1”

Bottom slot → “0”

The above dip-switch setting “1 0 0 1 0 0” corresponds to “channel 36” in the system channels table on page 26.

2. Continuous Transmitting Time Adjustment

(Type 1)

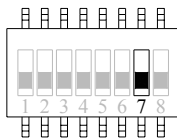

→

After the push button is released the transmitter will continue to transmit neutral signals to the receiver for up to one (1) minute. After one (1) minute the transmitter will cease transmission thus temporarily disconnecting the receiver MAIN.

(Type 2)

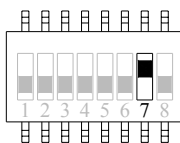

→

After the push button is released the transmitter will continue to transmit neutral signals to the receiver for up to three (3) minutes. After three (3) minutes the transmitter will cease transmission thus temporarily disconnecting the receiver MAIN. Please contact your local dealer if your application requires transmitting on time other than the preset value above.

3. Push Button Functions with LED Displays

A. Standard Push Button Configuration (Transmitter Toggle)

Set transmitter toggled (latching output relay) function by adjusting the 8-position function dip-switch located on the backside of the transmitter encoder board (refer to Fig. 09 below).

The LED 1 through LED 4 shown inside the shaded box (see below) illustrates which LED on the transmitter will light up when the designated push button (PB5 ~ PB8) is pressed.

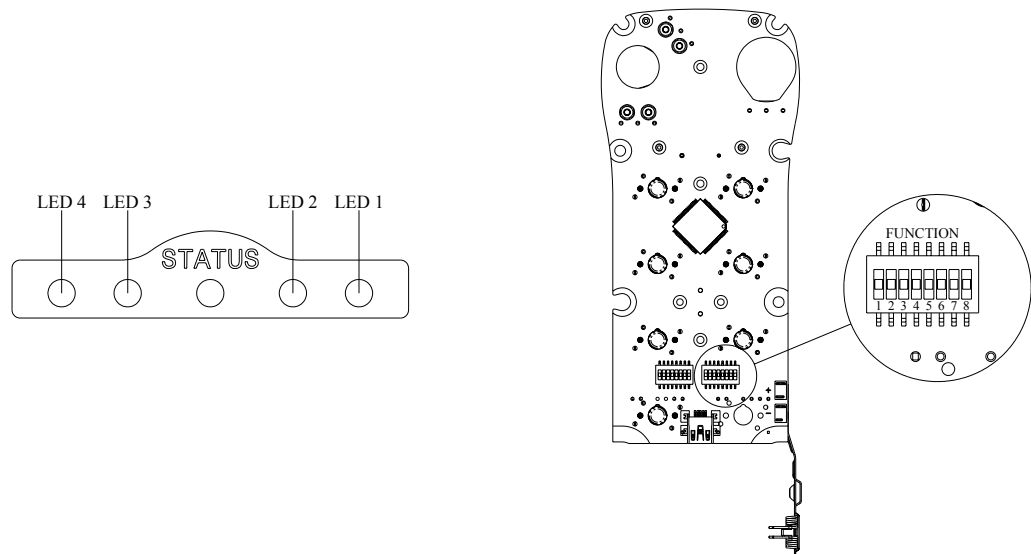

(Fig. 09)

	DIP	PB5	PB6	PB7	PB8
1	00000000	Normal	Normal	Normal	Normal
2	00000101	Normal	Normal	Normal	LED 4
3	00000110	Normal	Normal	LED 3	LED 4
4	00000111	Normal	LED 2	LED 3	LED 4
5	00001000	LED 1	LED 2	LED 3	LED 4

* PB5...PB8 → Push button number

* Normal → Normal momentary contact

* LED 1...LED 4 → Transmitter toggled with designated LED Display

B. Standard Push Button Configuration (A/B Selector)

There are four (4) different types of A/B selector sequence available on the Flex system.

Choose the one that is most suitable for your application.

Type-A selector sequence : A → B → A → B ...

Type-B selector sequence : Off → A → B → Off → A → B ...

Type-C selector sequence : A → B → A+B → A → B → A+B ...

Type-D selector sequence : Off → A → B → A+B → Off → A → B → A+B ...

	DIP	PB5	PB6	PB7	PB8
6	00101111	Normal	Normal	A/1&2	Normal
7	00110000	Normal	Normal	B/1&2	Normal
8	00110001	Normal	Normal	C/1&2	Normal
9	00110010	Normal	Normal	D/1&2	Normal
10	00110011	Normal	Normal	Normal	A/3&4
11	00110100	Normal	Normal	Normal	B/3&4
12	00110101	Normal	Normal	Normal	C/3&4
13	00110110	Normal	Normal	Normal	D/3&4
14	00110111	Normal	Normal	A/1&2	A/3&4
15	00111000	Normal	Normal	A/1&2	B/3&4
16	00111001	Normal	Normal	A/1&2	C/3&4
17	00111010	Normal	Normal	A/1&2	D/3&4
18	00111011	Normal	Normal	B/1&2	B/3&4
19	00111100	Normal	Normal	B/1&2	C/3&4
20	00111101	Normal	Normal	B/1&2	D/3&4
21	00111110	Normal	Normal	C/1&2	C/3&4
22	00111111	Normal	Normal	C/1&2	D/3&4
23	01000000	Normal	Normal	D/1&2	D/3&4

* PB5...PB8 → Push button number

* Normal → Normal momentary contact

* A/1&2...D/3&4 → A/B Selector type with designated LED Display (LED 1&2 or LED 3&4)

C. Inline Push Button Configuration (Transmitter Toggle)

The push button arrangement for inline push button setup starts from top to bottom and then from right column to left column (refer to Fig. 10 below). To set inline push button configuration please refer to JP4 and JP5 jumpers setting on page 24. With inline push buttons configuration, PB1 & PB2 still corresponds to output relay K1~K4, PB3 & PB4 corresponds to relay K5~K8, etc...

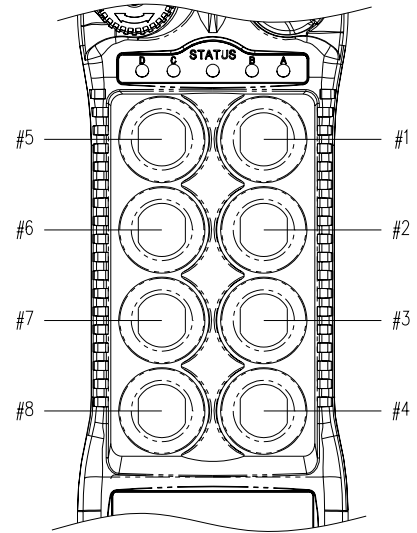

(Fig. 10)

	DIP	PB5	PB6	PB7	PB8
24	00000000	Normal	Normal	Normal	Normal
25	00000101	Normal	Normal	Normal	LED 4
26	00010100	Normal	Normal	LED 3	LED 4
27	00010101	Normal	LED 2	LED 3	LED 4
28	00010110	LED 1	LED 2	LED 3	LED 4

* PB5...PB8 → Push button number

* Normal → Normal momentary contact

* LED 1...LED 4 → Transmitter toggled with designated LED Display

D. Inline Push Button Configuration (A/B Selector)

There are four (4) different types of A/B selector sequence available on the Flex system.

Choose the one that is most suitable for your application.

Type-A selector sequence : A → B → A → B ...

Type-B selector sequence : Off → A → B → Off → A → B ...

Type-C selector sequence : A → B → A+B → A → B → A+B ...

Type-D selector sequence : Off → A → B → A+B → Off → A → B → A+B ...

	DIP	PB5	PB6	PB7	PB8
29	01110011	Normal	Normal	A/1&2	Normal
30	01110100	Normal	Normal	B/1&2	Normal
31	01110101	Normal	Normal	C/1&2	Normal
32	01110110	Normal	Normal	D/1&2	Normal
33	00110011	Normal	Normal	Normal	A/3&4
34	00110100	Normal	Normal	Normal	B/3&4
35	00110101	Normal	Normal	Normal	C/3&4
36	00110110	Normal	Normal	Normal	D/3&4
37	01110111	Normal	Normal	A/1&2	A/3&4
38	01111000	Normal	Normal	A/1&2	B/3&4
39	01111001	Normal	Normal	A/1&2	C/3&4
40	01111010	Normal	Normal	A/1&2	D/3&4
41	01111011	Normal	Normal	B/1&2	B/3&4
42	01111100	Normal	Normal	B/1&2	C/3&4
43	01111101	Normal	Normal	B/1&2	D/3&4
44	01111110	Normal	Normal	C/1&2	C/3&4
45	01111111	Normal	Normal	C/1&2	D/3&4
46	10000000	Normal	Normal	D/1&2	D/3&4

* PB5...PB8 → Push button number

* Normal → Normal momentary contact

* A/1&2...D/3&4 → A/B Selector type with designated LED Display (LED 1&2 or LED 3&4)

4. Channel Change via Push Buttons

Other than CHANNEL dip-switch on the encoder board, the transmitter channel can also be changed directly on the push buttons. Please refer to the instruction below on how to change transmitter channel via push buttons.

- a. Press and hold PB1, PB2 and PB3 and rotate the power key to START position at the same time. A series of green and red blinks will appear on the Status LED showing the current channel setting. A green blink represents the tens (+10) and a red blink represents the units (+1).

Examples: 2 green blinks followed by 5 red blinks represents channel 25.

6 red blinks represents channel 06.

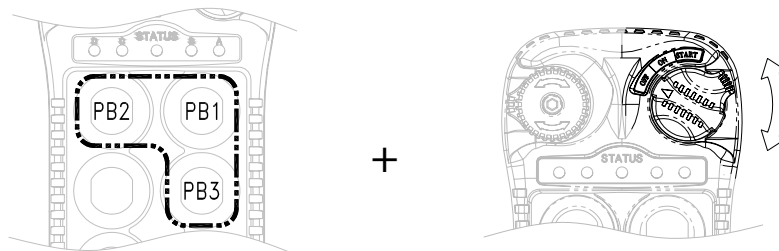

- b. Select new channel by pressing PB1 and PB2 on the transmitter. Press PB1 to increment the units (+1) and PB2 to increment the tens (+10).

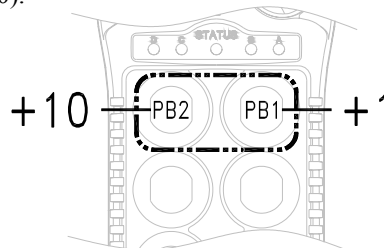

Examples: Press PB2 two times and then PB1 four times will give you channel 24.

Press PB1 nine times will give you channel 09.

- c. When finished, the newly selected channel will appear on the Status LED via series of green and red blinks again.
- d. Exit the channel programming by turning off the transmitter power.
- e. Make sure the receiver channel is set identical to the transmitter. Please refer to page 17 and page 32 on how to change receiver channel.
- f. Please note that when the CHANNEL dip-switch inside the transmitter is changed, the priority will revert back to the new channel set on the CHANNEL dip-switch.
- g. Please note that when channel is set beyond channel 62 via PB1 and PB2 (i.e. channel 63, 68, 88, etc...), the system will recognize it as channel 62.

5. Program 4-digit Security Code

Prior to rotating the transmitter power key-switch to START position to begin operation, you must first enter a 4-digit security code in order to proceed further. When this 4-digit security code is input correctly, a green light will appear on the Status LED. Please refer to the instruction below on how to program the 4-digit security code.

- a. Press and hold PB1, PB2, PB3 and PB4 and rotate the power key to START position at the same time.

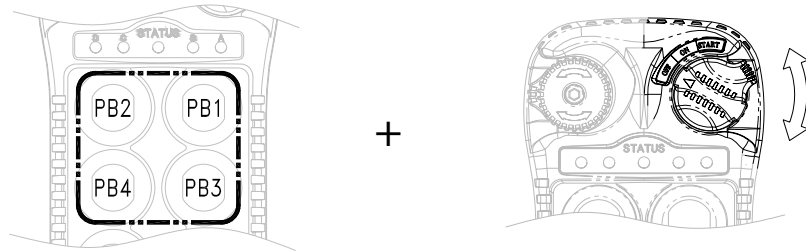

- b. A constant orange light will appear on the Status LED telling you that you are in the security code programming mode.
- c. For newly purchased system with the security code function deactivated (default setting), press PB1 four times (1111) to activate the security code function. At this time the Status LED on the transmitter will blink orange slowly telling you that the 4 digits entered is correct. Then select your own 4-digit security code by pressing PB1, PB2, PB3 or PB4 on the transmitter (four presses randomly). At this time a fast orange blinks is displayed on the Status LED telling you to reconfirm the 4-digit security code you have just entered. A green light will appear once you have re-entered the same 4-digit security code again (programming completed). If red light is shown on the Status LED after you have re-entered the security code (incorrect input), then you must reset the transmitter power and then repeat step a, b and c again.

Steps: Press and hold PB1~PB4 and rotate power key to START position → constant orange → press PB1 four times (for new systems) or 4-digit security code → slow orange blinks → enter the new 4-digit security code → fast orange blinks → re-enter the same 4-digit security code again → green light.

- d. If you wish to cancel the security code function, then repeat a, b, c above and press PB1 four times as your new security code (security code function disabled).
- e. If you do not remember the 4-digit security code, then you must contact your dealer or distributor for further assistance.

6. I-Chip

I-Chip functioned in a way that is very similar to a SIM card inside a mobile phone, which stores system information such as your phone number, account number, phone book and other settings.

I-CHIP works exactly the same way, as it stores information such as system serial number/ID code, channel and push button configurations.

When replacing a transmitter handset, just take the I-CHIP out of the old transmitter and install it into the new one (refer to Fig. 11 below). For complete information transfer, do make sure both the Channel and Function dip-switch is set to all "1". If both dip-switches are set to all "1", then the transmitter will operate according to the push button configurations and channel stored inside the I-CHIP. If both Channel and Function dip-switch is set to other values other than all "1", then the transmitter will operate according to the channel and push button configurations set on these two dip-switches, not the ones stored inside the I-CHIP. Every time when the settings on these two dip-switches have changed, the new settings will be stored into the I-CHIP automatically. In this case the previous channel and push button configurations stored inside the I-CHIP will be erased and be replaced by the new settings.

For safety purposes, system serial number/ID code stored inside the I-CHIP can not be changed directly on the transmitter encoder board. Only channels and push button configurations can be changed directly on the encoder board via Channel and Function dip-switches. There are only two ways that you can change transmitter serial number/ID code; 1) via I-CHIP programming port located on the decoder module inside the receiver unit, please refer to page 25 on how to program the I-CHIP (serial number/ID code) via receiver unit; 2) via an external I-CHIP programmer or duplicator unit available from the factory. Please ask your local dealers for assistance if your system requires serial number/ID code adjustments.

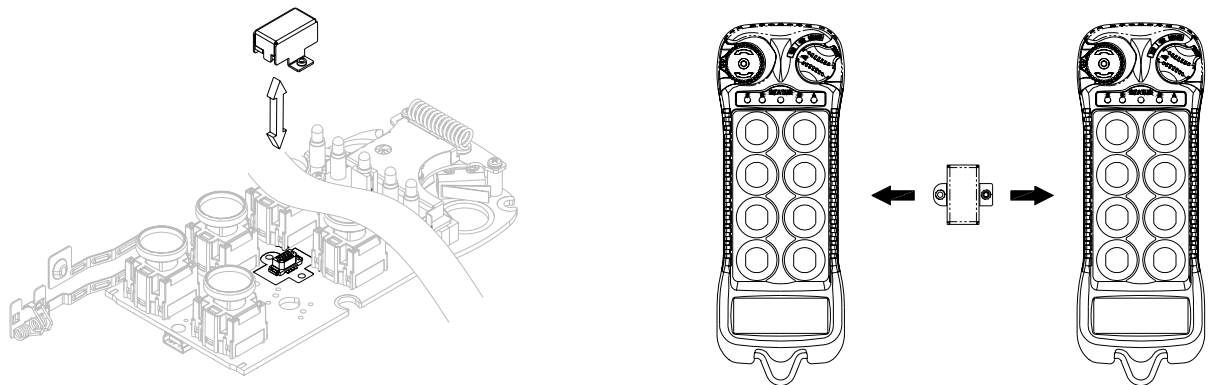

(Fig. 11)

B. RECEIVER UNIT

1. System Channel Settings

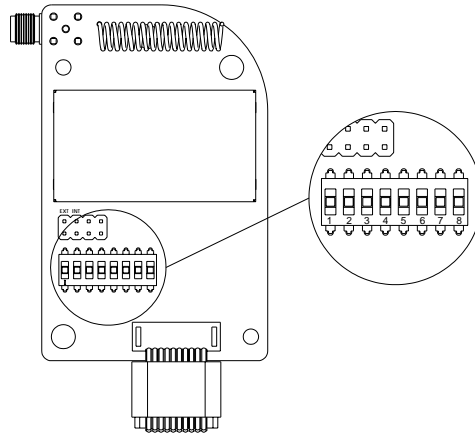

(Fig. 12)

Even though Flex system is equipped with automatic channel scanning receiver, the user can also set the receiver channel manually. Please refer to page 32 on how automatic channel scanning receiver works.

Set the receiver channel by adjusting the channel dip-switch located on the receiver module (refer to Fig. 12 above), only the first six (6) positions are used for channel programming (refer to Fig. 13 below). The system channels table located on page 26 illustrates which dip-switch setting corresponds to which channel. Once the receiver channel is altered do make sure to change transmitter channel as well. The channel on both transmitter and receiver must be identical in order for system to work. To change transmitter channel please refer to page 9.

Example:

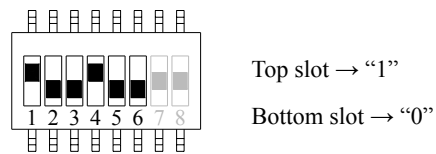

(Fig. 13)

The above dip-switch setting “1 0 0 1 0 0” corresponds to “channel 36” in the system channels table on page 26.

2. Output Relay Configurations

a. Output Relay Types

1. Three (3) output relays per motion – shared 2nd speed output relay

Output relays with Forward 1st speed (F1), Reverse 1st speed (R1) and Forward/Reverse 2nd speed (F/R2). Forward and Reverse 2nd speed (F/R2) shared the same output relay.

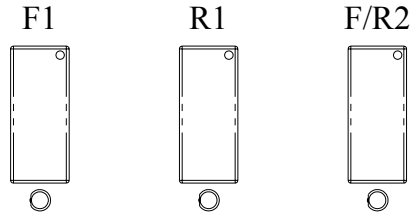

2. Four (4) output relays per motion – separate 1st and 2nd speed output relays

Output relays with Forward 1st speed (F1), Reverse 1st speed (R1), Forward 2nd speed (F2) and Reverse 2nd speed (R2). Forward and Reverse 2nd speed with separate output relays.

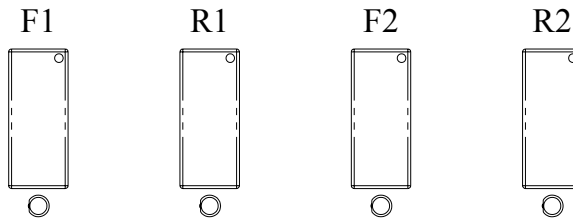

b. Output Relay Actions at 2nd Speed

1. 3-output relays configuration with Closed/Closed contact at 2nd speed

At 2nd speed, both 1st speed (F1 or R1) and 2nd speed (F/R2) output relays are closed (refer to page 22 on how to set to this function).

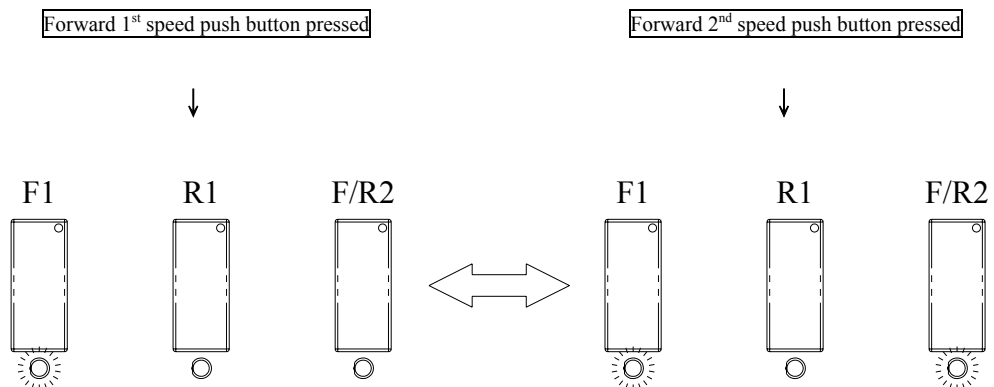

2. 4-output relays configuration with Opened/Closed contact at 2nd speed

At 2nd speed, only the 2nd speed (F2 or R2) output relay is closed (refer to page 22 on how to set to this function).

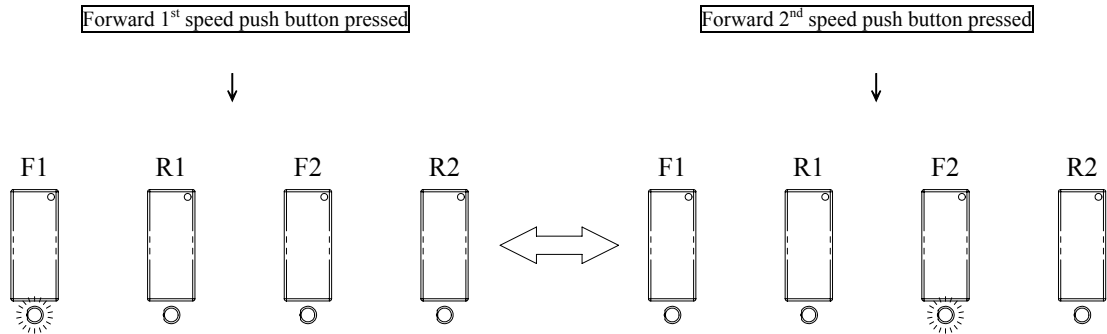

3. 4-output relays configuration with Closed/Closed contact at 2nd speed

At 2nd speed, both 1st speed (F1 or R1) and 2nd speed (F2 or R2) output relays are closed (refer to page 22 on how to set to this function).

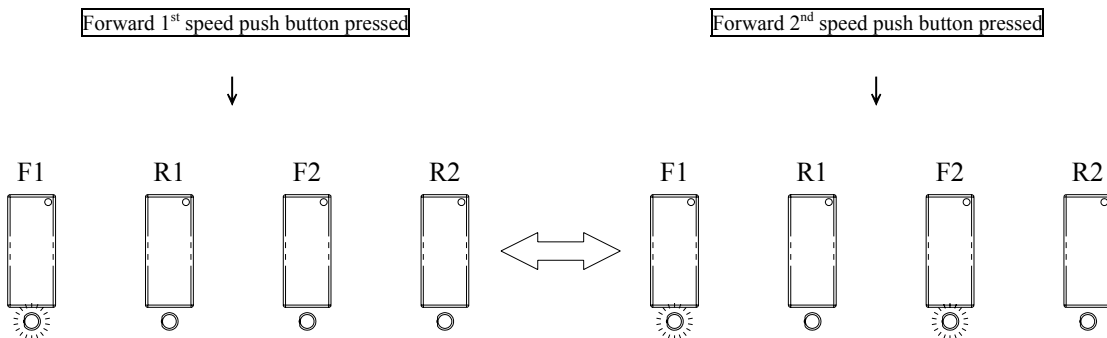

c. ON/OFF Push Button Function

The user can set any of the two adjacent push buttons on the transmitter to behave like a mechanical ON & OFF rocker switch (refer to page 22 on how to set to this function). When “On” output relay is closed (“On” push button pressed), the “Off” output relay will open automatically, or vice versa.

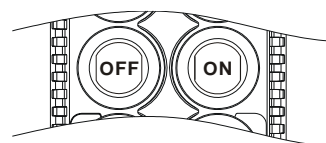

d. Magnet ON/OFF Push Button Function

The user can set any of the two adjacent push buttons on the transmitter to control a magnet. To activate the magnet just press the push button with the Magnet symbol. To deactivate the magnet, for safety purpose, you must first press and hold the Magnet push button and then press the OFF push button. Press the OFF push button by itself can not deactivate the magnet (refer to page 22 on how to set to this function).

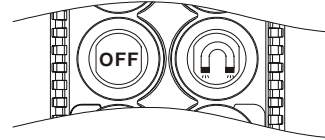

e. Brake Function

When the transmitter push button is released from 2nd speed up to 1st speed, both 1st and 2nd speed output relays will open for up to 1.0 second and then with 1st speed output relay closed thereafter (refer to page 22 on how to set to this function).

f. External Warning Function

The user can install an external warning device (rotating lights, horn, etc...) to a special “Function output relay” located inside the receiver. The user can choose which push button pairs or crane motions he desired to have external warnings when push button is pressed (refer to page 22 on how to set to this function).

g. Momentary Contact

When push button is released the output relay corresponds to that push button will open (refer to page 23 on how to set to this function). This type of contact is usually applies to external application such as horns or buzzers.

h. Toggled Contact

When push button is released the output relay corresponds to that push button will remained closed (maintained contact) until next time the user presses the same push button again (refer to page 23 on how to set to this function). This type of contact is usually applies to external application such as lights.

i. 3rd Speed Push Button Function

This function allows the crane to travel an additional step beyond 2nd speed. For example, if the operator is pressing the “UP” push button down to 2nd speed, pressing the 3rd speed push button (with “UP” push button still hold at 2nd speed) will toggle between 2nd speed and 3rd speed (refer to page 23 on how to set to this function).

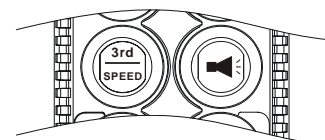

j. Auxiliary STOP Push Button Function (JP3 must be inserted)

The auxiliary STOP function acts as a 2nd emergency stop button. Other than by emergency stop button and transmitter power key switch, the receiver MAIN is also deactivated when this auxiliary stop push button is pressed (refer to page 23 on how to set to this function).

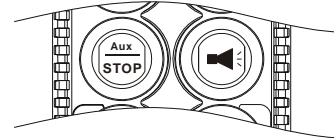

k. Pitch & Catch Function

This function allows two operators controlling one crane from opposite ends of a cross or long travel (refer to page 23 on how to set to this function). When set to “Pitch & Catch” make sure the 2nd transmitter is set to the next upper channel (channel X*+1). For example, if the system is preset at “Ch.01” then the channel of the 2nd transmitter should be set to “Ch.02”. Furthermore, the dip-switch position #7 and #8 on the receiving module should be set to “10”, this will allow the receiver to scan only Ch.01 and Ch.02 (please refer to the illustration below). On the other hand, since there are only 62 available channels on the Flex system, the system preset at channel 62 is ineffective because the 2nd transmitter can not be set to Ch.63. If your system is preset at Ch.62 do make sure to change it to another channel.

3. Receiver Auto-Scanning Settings

Receiver Channel Dip-switch

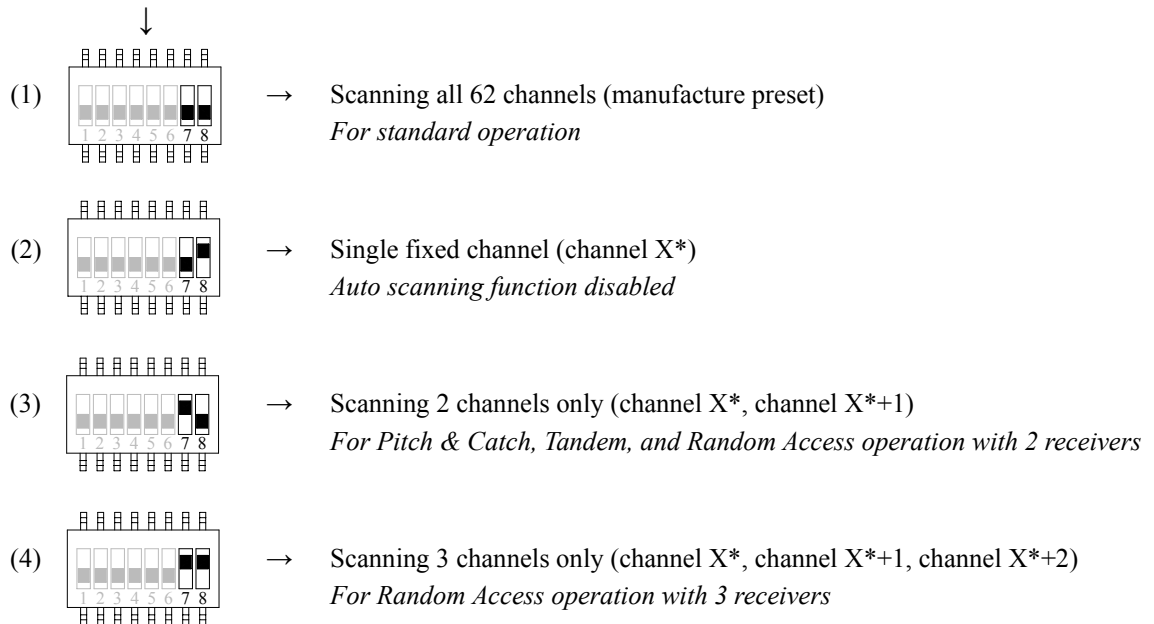

* Channel X → Channel set on the receiving module

Example: If the first 6 dip-switch positions on the receiving module is set to Ch.01 (“000000” or “000001”), when set to 2-channel scanning (type-3 above), then the receiver will only scan Ch.01 and Ch.02.

4. Dip-Switch Settings

a. Interlocked Functions

Interlocked means the two adjacent push buttons can not be activated simultaneously at the same time as it will cancel each other out. Interlocked settings are usually applied to crane's forward and reverse motions. Each dip-switch on the decoder module corresponds to one (1) motion or two (2) adjacent push buttons (refer to Fig. 14 & 15 below). Only the first 7 dip-switch positions are used (counting from left to right), the 8th dip-switch position (far right) is not used.

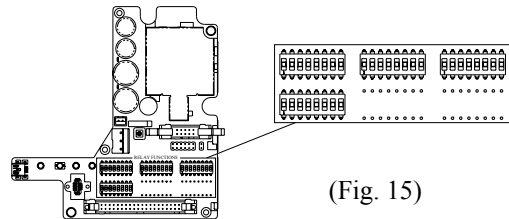
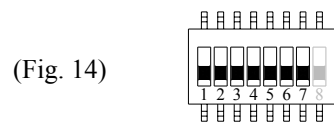

■ Manufacture preset

Dip Settings	Function Descriptions	# of Relays Used
0000000	Normal (single speed only, F2 & R2 relays not used)	2
0000001	Closed/Closed Relay Action at 2 nd Speed (separate 2 nd speed relay)	4
0000010	Closed/Closed Relay Action at 2 nd Speed (shared 2 nd speed relay)	3
0000011	Opened/Closed Relay Action at 2 nd Speed (separate 2 nd speed relay)	4
0000110	On (right button) & Off (left button)	2
0001001	On + Start / Off + Start -- Prior to pressing the button you must first rotate and hold the power key switch at START position to activate On or Off relays.	2
0000111	Safety Magnet On & Off	2
0001010	FWD/REV toggled (latching)	2
0010000	Normal + External Warning*	2
0010001	Closed/Closed Relay Action + External Warning*	4
0010010	Closed / Closed Relay Action + External Warning*	3
0010011	Opened/Closed Relay Action + External Warning*	4
0100001	Closed/Closed + Brake	4
0100010	Closed/Closed Relay Action + Brake	3
0100011	Opened/Closed Relay Action + Brake	4
0110001	Closed/Closed Relay Action + Brake + External Warning*	4
0110010	Closed/Closed Relay Action + Brake + External Warning*	3
0110011	Opened/Closed Relay Action + Brake + External Warning*	4

* External warning function requires installing an external warning device such as horn and rotating lights to the function relay output.

b. Non-Interlocked Functions

Contrary to interlocked settings, non-interlocked settings allow the two adjacent push buttons be used simultaneously at the same time. Non-interlocked settings are usually applied to crane's auxiliary functions such as lights, horn, 3rd speed, auxiliary stop and Pitch & Catch. Each dip-switch on the decoder module corresponds to one (1) motion or two (2) adjacent push buttons (left & right push buttons).

Function Code	Dip Position Setting #1	Dip Position Setting #2 ~ #4 (left button) & #5 ~ #7 (right button)	Function Description
A	1	000	Normal (momentary) contact
B	1	001	Toggled (latching) contact
C	1	010	Acceleration (3 rd speed)
D	1	100	Normal + Start function. For added safety, you must first rotate and hold the power key switch at "START" position and then press the intended push button at the same time to activate the output relay.
E	1	110	Pitch & Catch
F	1	111	Auxiliary Stop

Example #1: Left button (set to function code A) / right button (set to function code A) → **1 000 000**

Example #2: Left button (set to function code B) / right button (set to function code B) → **1 001 001**

Example #3: Left button (set to function code A) / right button (set to function code C) → **1 000 010**

Example #4: Left button (set to function code F) / right button (set to function code A) → **1 111 000**

! When set to Pitch & Catch function make sure the 2nd transmitter is set to the next upper channel. For example, if the system is preset at Ch.01 then the 2nd transmitter should be set to Ch.02. Furthermore, you must also set the dip-switch on the receiving module (position #7 & #8) to "10" position (2-channel scanning), please refer to page 21.

!! When set to "Auxiliary Stop" do make sure that JP3 is inserted (refer to jumper settings next page).

5. Jumper Settings

Jumper settings are applied to functions such as Start command, transmitter push button layout, system information (serial number/ID code) programming, and system testing. The jumpers #3 ~ #7 are located on the decoder module above the four (4) dip-switches (refer to Fig.16 below).

(Fig. 16)

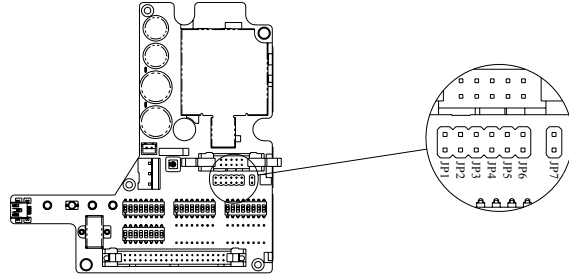

■ Manufacture preset

Jumper Settings		Function
JP3 (Blank)		After 1 or 3 minutes of transmitter inactivity (MAIN deactivated), press any push button on the transmitter to reactivate the receiver MAIN.
JP3 (Inserted)		After 1 or 3 minutes of transmitter inactivity (MAIN deactivated), rotate the transmitter power key-switch to "START" position to reactivate the receiver MAIN.
JP4 (Blank)	JP5 (Blank)	Standard right-to-left push button configuration for all models.
JP4 (Inserted)	JP5 (Blank)	In-line push button configuration (top to bottom) for FLEX 8ES/EX.
JP4 (Blank)	JP5 (Inserted)	In-line push button configuration (top to bottom) for FLEX 12ES/EX.
JP4 (Inserted)	JP5 (Inserted)	In-line push button configuration (top to bottom) for FLEX 4ES/EX.
JP6 (Blank)		Program system serial number/ID code and channel from decoder module to I-CHIP.
JP6 (Inserted)		Program system serial number/ID code and channel from I-CHIP to decoder module.
JP7 (Inserted)		For system test only, receiver MAIN disabled.

6. I-CHIP Programming Port

(Fig. 17)

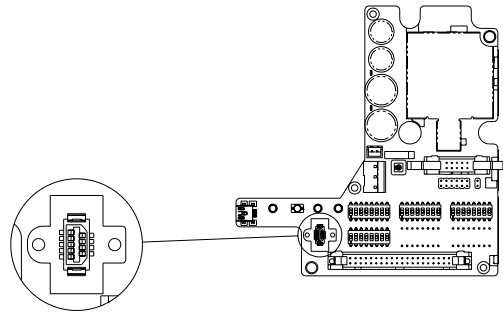

I-CHIP programming port located on the decoder module (refer to Fig. 17 above) inside the receiver is designed for the purpose of transferring system serial number/ID code either from I-CHIP to receiver or from receiver to I-CHIP. If you wish to transfer system information from receiver to I-CHIP, just insert the I-CHIP onto the programming port (JP6 jumper not inserted), wait until the Status LED on the decoder module turned constant green (within 2 seconds), and then take the I-CHIP out of the programming port (programming completed). At this time the I-CHIP should also possess the same serial number/ID code as the receiver. If the Status LED on the decoder module displayed a constant red light after inserting the I-CHIP (programming failed), then you must reinsert the I-CHIP one more time. On the other hand, if you wish to transfer system information from I-CHIP to receiver, then you must first insert JP6 jumper prior to inserting the I-CHIP, then wait for the green light to appear on the Status LED. At this time the receiver should also possess the same system information as the I-CHIP. Please note that the receiver unit must be powered in order to proceed with the programming.

7. Voltage Settings

Prior to installation always check the voltage setting is correct for your application (refer to Fig. 18 below).

- Position 1 → 110~120VAC
- Position 2 → 220~240VAC or 24VAC*
- Position 3 → 380VAC or 42VAC*
- Position 4 → 400~460VAC or 48VAC* or 12~24VDC**

* For system with 24/42/48VAC power supply.

** For system with 12~24VDC power supply.

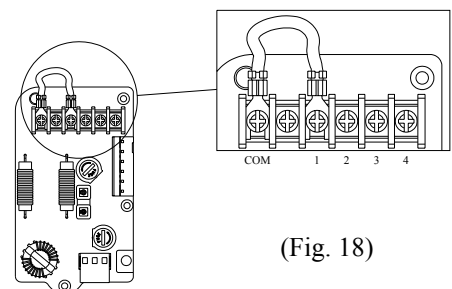

(Fig. 18)

F9 and F10 power fuse ratings:

FUSE #	110~120VAC	220~240VAC	380VAC	400~460VAC	24VAC	42 & 48VAC	12~24VDC
F9	1.0A (red)	1.0A (red)	1.0A (red)	0.5A (blue)	3.0A (yellow)	2.0A (purple)	2.0A (purple)
F10	1.0A (red)	1.0A (red)	1.0A (red)	0.5A (blue)	3.0A (yellow)	2.0A (purple)	2.0A (purple)

* Output relay fuse → 5.0A (clear)

5. System Channels Table

Channel	Frequency	Dip-switch Setting	Channel	Frequency	Dip-switch Setting
01	433.000MHZ	000000	32	433.775MHZ	100000
01	433.000MHZ	000001	33	433.800MHZ	100001
02	433.025MHZ	000010	34	433.825MHZ	100010
03	433.050MHZ	000011	35	433.850MHZ	100011
04	433.075MHZ	000100	36	433.875MHZ	100100
05	433.100MHZ	000101	37	433.900MHZ	100101
06	433.125MHZ	000110	38	433.925MHZ	100110
07	433.150MHZ	000111	39	433.950MHZ	100111
08	433.175MHZ	001000	40	433.975MHZ	101000
09	433.200MHZ	001001	41	434.000MHZ	101001
10	433.225MHZ	001010	42	434.025MHZ	101010
11	433.250MHZ	001011	43	434.050MHZ	101011
12	433.275MHZ	001100	44	434.075MHZ	101100
13	433.300MHZ	001101	45	434.100MHZ	101101
14	433.325MHZ	001110	46	434.125MHZ	101110
15	433.350MHZ	001111	47	434.150MHZ	101111
16	433.375MHZ	010000	48	434.175MHZ	110000
17	433.400MHZ	010001	49	434.200MHZ	110001
18	433.425MHZ	010010	50	434.225MHZ	110010
19	433.450MHZ	010011	51	434.250MHZ	110011
20	433.475MHZ	010100	52	434.275MHZ	110100
21	433.500MHZ	010101	53	434.300MHZ	110101
22	433.525MHZ	010110	54	434.325MHZ	110110
23	433.550MHZ	010111	55	434.350MHZ	110111
24	433.575MHZ	011000	56	434.375MHZ	111000
25	433.600MHZ	011001	57	434.400MHZ	111001
26	433.625MHZ	011010	58	434.425MHZ	111010
27	433.650MHZ	011011	59	434.450MHZ	111011
28	433.675MHZ	011100	60	434.475MHZ	111100
29	433.700MHZ	011101	61	434.500MHZ	111101
30	433.725MHZ	011110	62	434.525MHZ	111110
31	433.750MHZ	011111	I-CHIP		111111*

* When set to all "1" the priority goes to the channel assigned inside the I-CHIP.

6. Receiver Installation

A. OUTPUT RELAY CONTACT DIAGRAM

Push button 1~2

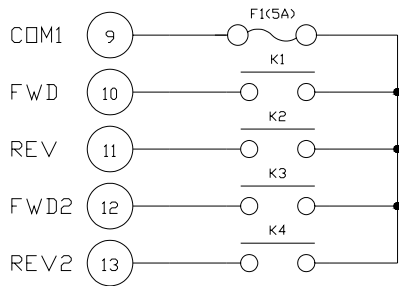

Push button 5~6

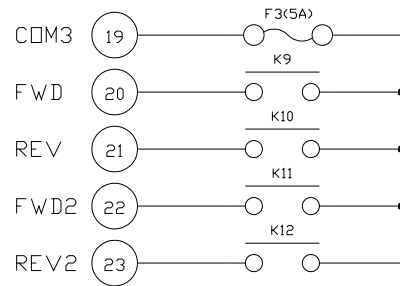

Push button 3~4

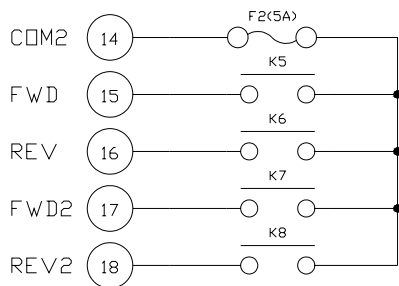

Push button 7~8

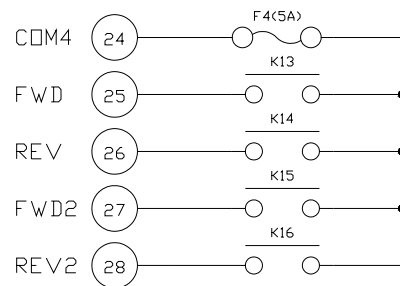

MAIN / ID / Function

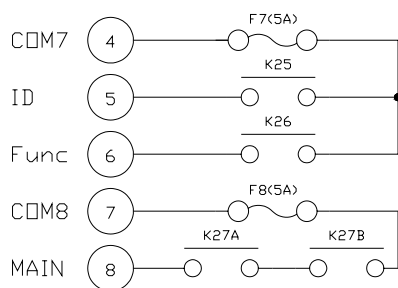

Power

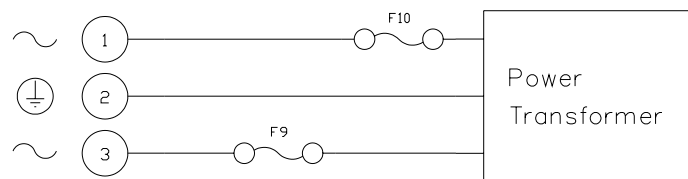

- * For 3-relay (shared 2nd speed) and 4-relay (separate 2nd speed) configuration please refer to page 18~22.
- * For 4-relay closed/closed and 4-relay opened/closed relay configuration please refer to page 18~22.
- * For different voltage settings please refer to page 25.
- * For F9 and F10 power fuse ratings please refer to page 25.
- * For 12~24VDC power supply, wire #1 corresponds to the negative charge (-) and wire #3 corresponds to the positive charge (+), wire #2 is for GROUND.

B. PRE-INSTALLATION PRECAUTIONS

1. Make sure the transmitter and receiver are with identical serial number/ID code and channel.
2. Make sure the receiver is not set to the same channel as any other systems in use in the surrounding area.
3. Make sure that the crane or equipment is working properly prior to installation.
4. Make sure the power source to the receiver is set correctly.
5. Switch off the main power source to the crane or equipment prior to installation.

C. STEP-BY-STEP INSTALLATION

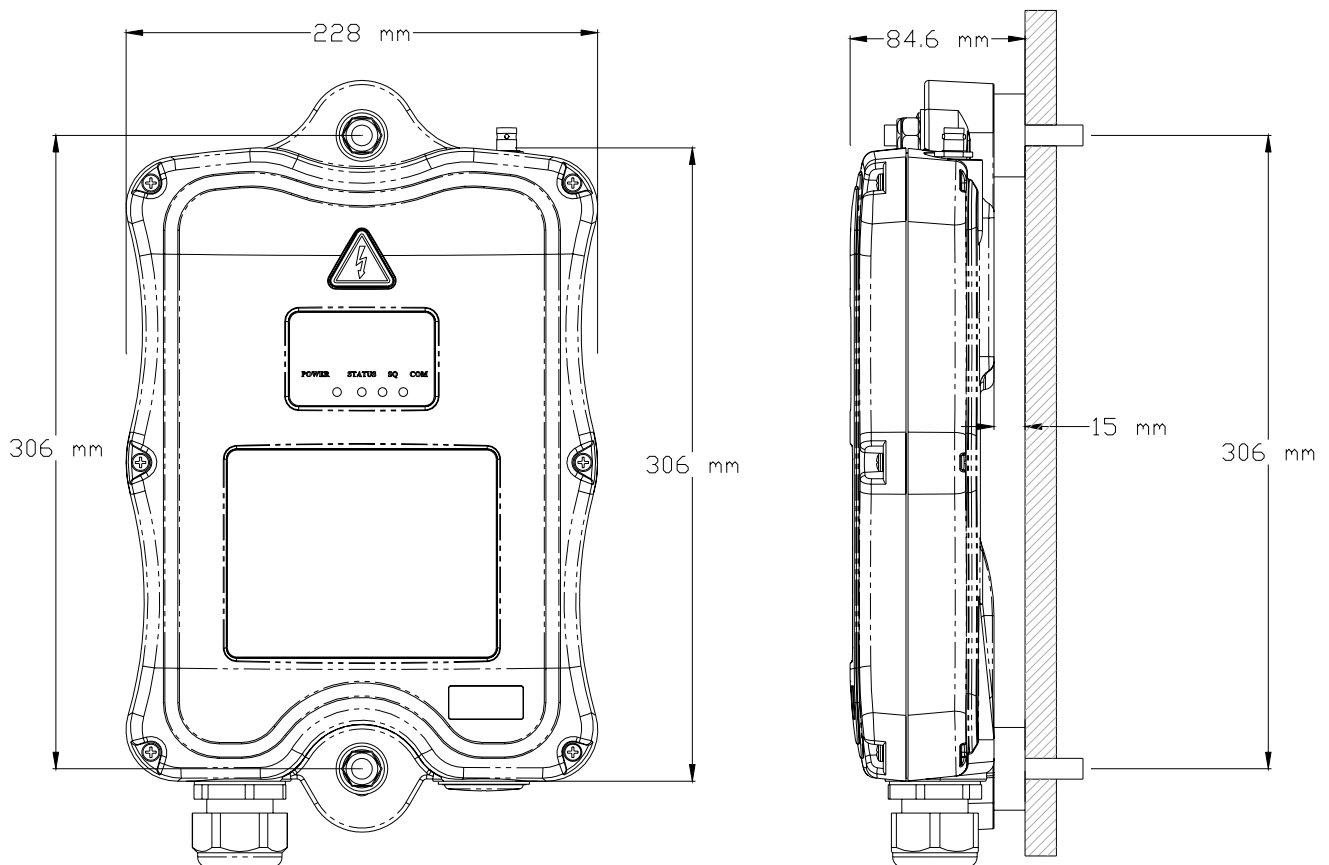

(Fig. 19)

1. For best reception the location of the receiver should be visible to the operator at all time.
2. The location selected should not be exposed to high levels of electric noise. Mounting the receiver next to an unshielded variable frequency drive may cause minor interference. Always locate the receiver as far away from variable frequency drive as possible.
3. Ensure the selected location has adequate space to accommodate the receiver (refer to Fig. 19 on page 28). If an external antenna is used, to avoid the possibility of antenna damage always locate the receiver where the antenna is free from any obstacles from all directions (refer to diagram at right).
4. When using the external antenna you must make sure to set the jumper to “EXT” position (refer to diagram below).

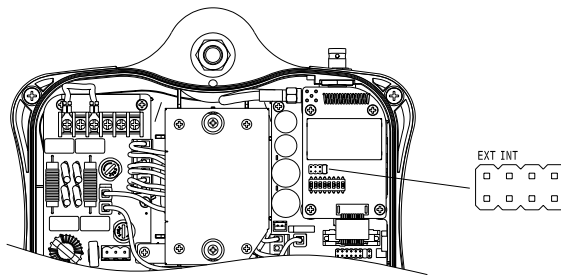
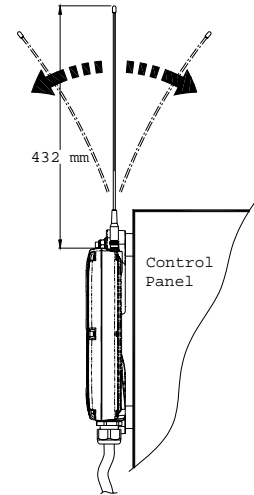

5. For better reception, make sure the receiver is in an upright position.
6. Drill two holes (10mm in diameter) on the control panel or location where the receiver is to be installed (refer to Fig. 19 on page 28).
7. Make sure the two bolts are tightened after installation.
8. For system wiring please refer to page 27.

D. SYSTEM TESTING

1. Turn on the power source to the receiver and test the MAIN relay output by pressing the red emergency stop button and observe that it properly opens and closes the mainline disconnect contactor.
2. Test the operation of each function to ensure it corresponds to the transmitter direction labels or the pendant it is replacing.
3. Test the limit switches (if any) to see if they are working properly.
4. If your new remote control is replacing an existing pendant, make sure it is completely disconnected and placed in a safe location to prevent unwanted control command.

7. Operating Procedure

A. TRANSMITTER OPERATION

1. General Operating Procedure

- a. Reset the red emergency stop button located on the top left hand side of the transmitter handset by rotating it either clockwise or counter clockwise, the red button will pop up.

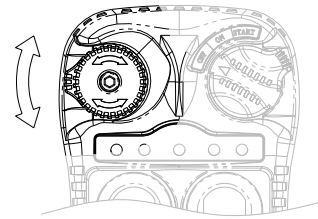

- b. Turn on the transmitter power by inserting the black-colored key into the power key slot located on the top right hand side of the transmitter handset and rotate it clockwise to “On” position.

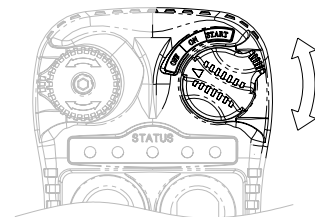
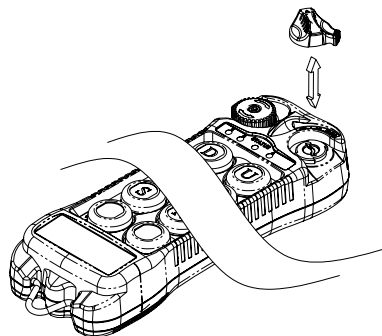

- c. After turning the transmitter power on, check the Status LED on the transmitter handset for any sign of system irregularities (refer to “Status Light Indicators & Warnings” on page 33). If the system is normal the Status LED will light up green for two (2) seconds.
- d. If there are no signs of any system irregularities, then rotate the power key-switch further to START position for up to 1.0 second to activate all transmitter push button functions and as well as the receiver MAIN. Then press any push button on the transmitter to begin operation. Pressing any push button prior to initiating the START command will result in no signal transmitted (blinking orange light).

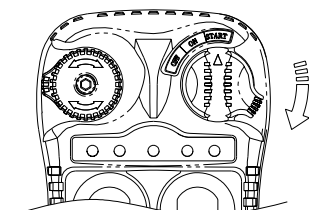

- e. In case of an emergency, pressing down the red emergency stop button will immediately disconnect the receiver MAIN and as well as the transmitter power. To resume operation, rotate the red button clockwise or counter clockwise, it will pop up. Then rotate the power key-switch to START position for up to 1.0 second to activate all transmitter push button functions and the receiver MAIN. Please note that every time when you turn the transmitter power off and back on again, or after resetting the emergency stop button, all push button functions will be locked to avoid any unintentional controls. For safety, initiating the START command after turning on the transmitter power or after resetting the emergency stop button is strictly required.
- f. After 1 minute of inactivity (push button not pressed) the receiver MAIN will be disconnected temporarily. To resume operation, just press any push button on the transmitter to resume operation (depending on JP3 setting on page 24). If this 1-minute inactivity time is not sufficient for your application, you can also extend this inactivity time from 1 minute up to 3 minutes (refer to Continuous Transmitting Time Adjustment on page 9). The receiver MAIN will also be disconnected temporarily when the receiver encounters strong radio interference or when the operator is controlling the crane or equipment beyond the transmitting range.
- g. To turn off the transmitter power just rotate the power key to “Off” position, it will disconnect the transmitter power and the receiver MAIN altogether.

2. A/B Selector Push Button Operating Procedure

Pressing the “Select A/B” push button will toggle between output relay A, B, A+B respectively. There are 4 different types of Select A/B sequence available, please refer to page 11 for instructions on how to set Select A/B functions.

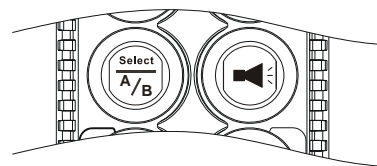
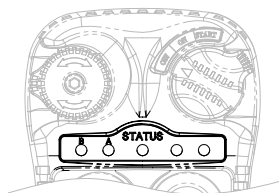

3. 3rd Speed Push Button Operating Procedure

When a push button is hold at 2nd speed, pressing the 3rd Speed push button one time will activate the 3rd speed output relay (toggled). If the operator wants 2nd speed again, just press the 3rd Speed push button one more time.

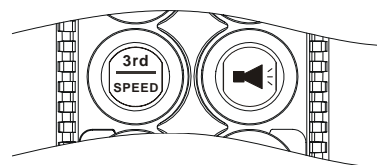

4. Pitch & Catch Operating Procedure

To release control of the crane, press the “Pitch” push button. To take over control of the crane, rotate the power key switch to “Catch” position for up to 2 seconds. The 2nd operator “can not” take control of the crane unless the 1st operator presses the “Pitch” push button (2.0 seconds). If the operator unintentionally presses the “Pitch” push button during operation, just rotate the power key to “Catch” position for up to 2 seconds to regain control again.

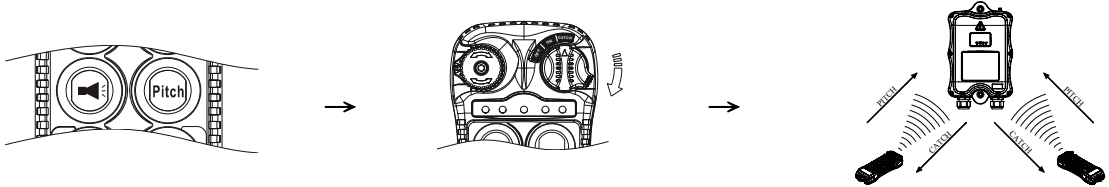

5. Automatic Channel Scanning Operating Procedure

After changing transmitter channel (refer to page 9), turn on the transmitter power and rotate the power key switch to “Start” position and hold it there for up to 1.0 minute. Within this 1-minute period the receiver will search (channel 01 ~ channel 62) and lock onto the newly selected transmitter channel automatically. Please note that in order for the receiver to switch to auto-scanning mode, prior to changing the transmitter channel, you must first deactivate the receiver MAIN by shutting off the transmitter power or press down the emergency stop button. Please refer to page 21 if you do not want the receiver to auto-scan all 62 channels.

Change Transmitter Channel

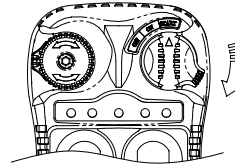

6. Changing Transmitter Batteries

Changing transmitter batteries by unscrewing the battery cover located on the backside of the transmitter (refer to Fig. 20 below). During battery installations make sure that the blue ribbon is centered between the two batteries. After changing the batteries also make sure that all screws are tightened to avoid water, moisture, dirt, grease, or other liquid penetration.

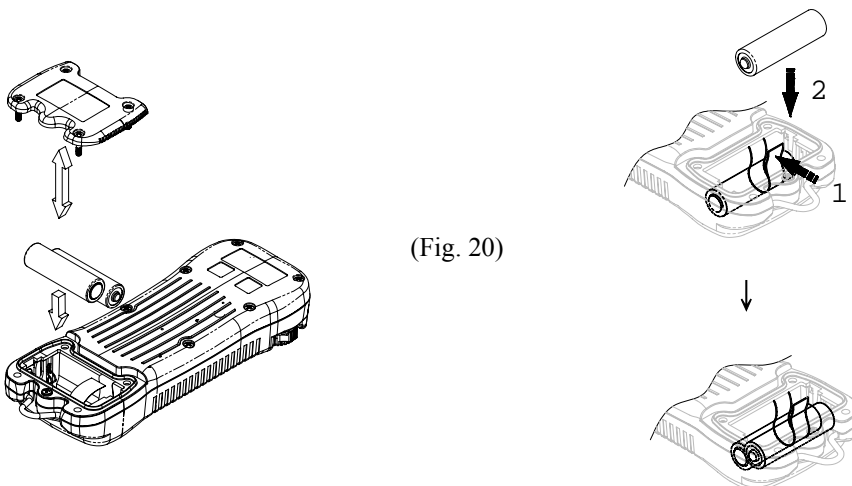

(Fig. 20)

B. STATUS LIGHT INDICATORS & WARNINGS

1. Transmitter STATUS Light Indication

Type	Display Type	Indication
1	Constant red	Voltage below 1.9V at initial power on, transmitter power and receiver MAIN shuts off.
		Voltage below 1.8V during operation, transmitter power and receiver MAIN shuts off.
2	1 red blinks followed by a 2-second pause	Voltage below 1.85V during operation, warning, change batteries suggested.
3	2 red blinks followed by a 2-second pause	The pushbutton is defective after turning on the transmitter power.
4	No light displayed	When defective push button condition occurs (2 red blinks, type 3 above), find out which push button is defective by pressing all the push buttons on the transmitter one at a time. If the push button is in good working order, the LED will not light up when pressed. If the push button is defective the LED will continue to display 2 red blinks when pressed.
5	3 red blinks followed by a 2-second pause	EEPROM error.
6	4 red blinks followed by a 2-second pause	Transmitting error, system can not locked on to the designated channel.
7	Constant green for up to 2 seconds	Transmitter power on with no faults detected.
8	Blinking green	Transmission in progress.
9	Blinking orange	Transmitter push button functions locked.

2. Receiver STATUS Light Indication

Type	Display Type (Green & Red)	Indication
1	Fast green blinks	Decoding in process
2	Slow green blinks	Decoding on standby
3	Two red blinks	Receiver MAIN jammed or defective
4	Fast red blinks	Incorrect transmitter serial number/ID code
5	Constant red	Receiver under-voltage, LV output relay activated
6	No light displayed	Decoding microprocessor is defective

3. Receiver SQ Light Indication

Type	Display Type (Red)	Indication
1	Fast blinks	Transmission received
2	Completely off	No transmission
3	Blinks intermittently	Other radio interference

4. Receiver POWER Light Indication

Type	Display Type (Red)	Indication
1	On	Power to receiver
2	Off	No power to receiver

5. Receiver COM Light Indication

Type	Display Type (Red)	Indication
1	On	Power to relay Board
2	Off	No power to relay board

C. TROUBLE SHOOTING TIPS

Problems	Possible Reasons	Suggestions
No responds when transmitter push button is pressed (Improper startup & settings)	Transmitter low battery power	Check the transmitter battery level.
	Emergency stop button activated prior to startup	Prior to turning on the transmitter power switch make sure that the red emergency stop button is elevated.
	Transmitter push button functions locked	Initiate the Start command by rotating the power key-switch to START position.
	Incorrect system RF channel	Check and make sure that the transmitter handset and receiver unit both have the same channel.
	Incorrect system serial number/ID code	Check and make sure that the transmitter handset and receiver unit both have the same serial number/ID code.
	System out of range	Make sure that the operating distance is within the control range.
No responds when transmitter push button is pressed (Damaged hardware)	Defective transmitting and receiving module	Check the SQ display on the face of the receiver unit. If it does not light up when push button is pressed then either the transmitting or receiving module is defective. First replace the transmitting module. If SQ display still not lid when push button is pressed then go ahead and replace the receiving module.
	Defective encoder board or decoder module	If still no responds, then replace the transmitter encoder board. If still doesn't work then the decoder module is defective.
No AC power to the receiver	Incorrect input voltage	Make sure the source voltage is set correctly.
	Blown fuse	Check for any blown fuse.
	Incorrect wiring	Check input voltage connection.
Outputs do not correspond to transmitter	Incorrect output connection	Check the system wiring again. Please refer to the output contact diagram inside this manual or on the receiver cover.

8. System Specifications

Frequency Range	:	433 ~ 434 MHz
Number of Channels	:	62 channels
Channel Spacing	:	25 KHz
Modulation	:	Digital Frequency Modulation based on Manchester Code, 20bit address, 32bit CRC Parity Check and Hamming Code.
Encoder & Decoder	:	Microprocessor-controlled
Transmitting Range	:	> 100 Meters / 300 Feet
Hamming Distance	:	> 6
Frequency Control	:	Synthesized PLL (Phase Lock Loop)
Receiver Type	:	Frequency Auto Scanning
Receiver Sensitivity	:	-116dBm
Spurious Emission	:	-50dB
Antenna Impedance	:	50 ohms
Responding Time	:	40 Milliseconds (average)
Transmitting Power	:	1.0mW
Enclosure Type	:	NEMA-4X
Enclosure Rating	:	IP-66
Output Contact Rating	:	250V @ 10 Amps
Transmitter Operating Voltage	:	DC 3.0V
Receiver Power Consumption	:	11.0 VA
Operating Temperature	:	-25°C ~ 75°C / -13°F ~ 167°F
Transmitter Dimension	:	184mm (L) x 69mm (W) x 34mm (H)
Receiver Dimension	:	363mm (L) x 228mm (W) x 70mm (H)
Transmitter Weight	:	242g / 8.5oz
Receiver Weight	:	2.5kg / 5.5lb

9. Spare Parts

1.	Transmitting Module (433/434MHz)	TRB 01
2.	Encoder Board (complete with push buttons)	ENB 05
3.	I-CHIP (complete)	ICP 01
4.	Receiving Module	RVB 01
5.	Decoder Module	DEB 02
6.	Receiver Relay Board	RLB 05
7.	AC Line Filter Board	LFB 01
8.	Power Transformer	
	AC 110~120V/220~240V/380V/400~460V	PTF 01
	AC 24V/42V/48V	PTF 02
	DC 12V~24V	PTF 03
9.	Transmitter Top Casing	TTC 02
10.	Transmitter Bottom Casing	TBC 02
11.	Transmitter Battery Cover	TBC 04
12.	Receiver Top Casing	RTC 01
13.	Receiver Bottom Casing	RBC 01
14.	Cord Grip	CGR 01
15.	Shock Mount	SMT 01
16.	2-Step Push Button	PBN 02
17.	3-Stage Mechanical Selector Switch	SWT 01
18.	Push Button Rubber Boot	PRB 01
19.	Emergency Stop Button	EMS 01
20.	Transmitter Power Keys Switch	PWK 01
21.	Waist Belt	WBT 01
22.	Strap Ring	STR 01
23.	Safety MAIN relay	SMR 01
24.	Regular Output Relay	RLY 01
25.	Clear Vinyl Pouch	CVP 02
26.	External Receiver Antenna	ANT 01

CE EU Declaration of Conformity CE

(EMC, R&TTE, SAFETY & MACHINERY)

For the following equipment:

Product : Flex Series Radio Remote Control System
Multiple Listee Model No. : Flex 4ES/EX, Flex 8ES/EX, Flex 12ES/EX
Manufacturer's Name : Advanced Radiotech Corporation
Manufacturer's Address : 1F, 288-3, Hsin Ya Road, Chien Chen District,
Kaohsiung City, Taiwan

We hereby declare, that all major safety requirements, concerning the CE Mark Directive (93/68/EEC) and Low Voltage Directive (73/23/EEC), Electromagnetic Compatibility Directives (89/336/EEC, 92/31/EEC), R&TTE Directive 1999/5/EC and 98/482/EC are fulfilled, as laid out in the guideline set down by the member states of the EEC Commission.

The standards relevant for the evaluation of the electrical safety requirements are as follow:

EMC: EN 301 489-3 V1.4.1 (2002-04)
R&TTE : EN 300 220-3 V1.1.1 (2000-09)
SAFETY : EN 60950:1999 (3rd Edition) / 2000 (3rd Edition)
MACHINERY: EN 60204-32:1998; EN954-1:1996; ISO 13849-1:1999
Category 3

Test reports issued by:

EMC: NEMKO Canada
R&TTE : NEMKO Canada
SAFETY : NEMKO Canada
MACHINERY: NEMKO Norway

Person responsible for marking this declaration:



Tom Jou / President

Name and signature of authorized person